

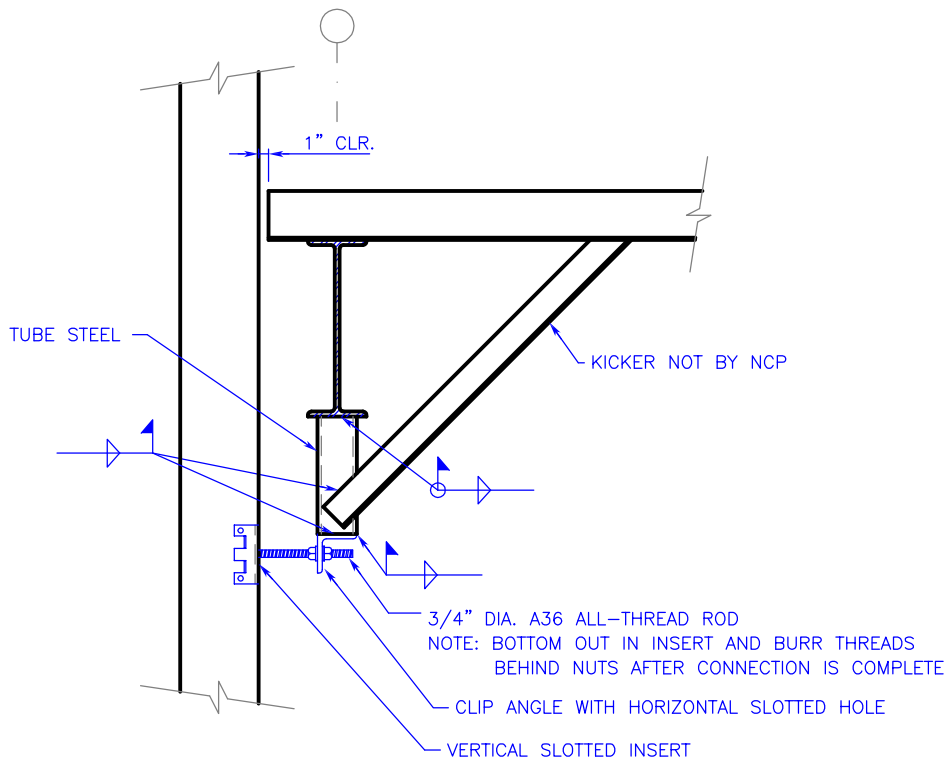

WALL PANEL CONNECTION DETAIL

PANEL CONNECTION THREADED ROD TIE-BACK



NITTERHOUSE
CONCRETE PRODUCTS

P. O. Box 2013
P: (717) 267-4505



Chambersburg, PA 17201
F: (717) 267-4518

www.nitterhouse.com

PAGE 8



October 2013