

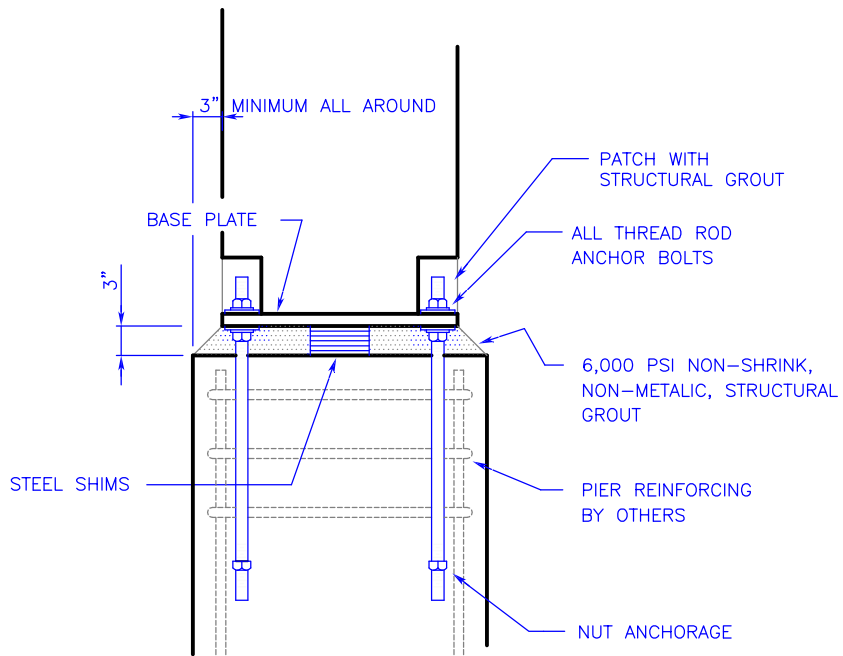

PARKING STRUCTURE CONNECTION DETAIL

PARKING GARAGE CONNECTION COLUMN BASE



NITTERHOUSE
CONCRETE PRODUCTS

P. O. Box 2013
P: (717) 267-4505



Chambersburg, PA 17201
F: (717) 267-4518

www.nitterhouse.com

PAGE 1



October 2013