

Prestressed Concrete Inverted Tee Beam 24IT32

PHYSICAL PROPERTIES

A = 558 in. ²	S _b = 3,390 in. ³
I = 44,984 in. ⁴	S _t = 2,402 in. ³
Y _b = 13.27 in.	Wt. = 581 PLF
Y _t = 18.73 in.	

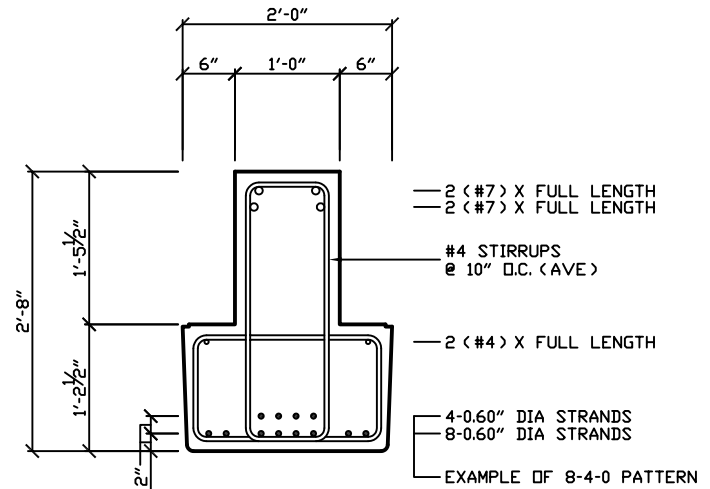

DESIGN DATA

1. Precast Strength @ 28 days = 6,000 PSI
2. Precast Strength @ release = 4,000 PSI.
3. Precast Density = 150 PCF
4. Strand = 0.60"Ø 270K Lo-Relaxation.
5. Ultimate moment capacity shown below is for full strand development & tension controlled section.
6. Maximum bottom tensile stress is $12\sqrt{f_c} = 930$ PSI
7. Flexural strength capacity is based on stress/strain strand relationships and is slightly variable.
8. Deflection limits were not considered when determining allowable loads in this table.
9. All superimposed live loads listed are controlled by ultimate flexural strength, not allowable stresses.
10. All superimposed load is treated as live load in the flexural strength analysis. To determine the allowable live load if the amount of superimposed dead load is known use the following conversion method...

$$\text{Allowable Live Load} = \frac{(1.6)(\text{Load Table Value}) - (1.2)(\text{Superimposed Dead Load})}{1.6}$$

11. If the above conversion is used then allowable stress limits must be checked so they are not exceeded.
12. The concrete strength at release of prestress force increases to 4,500 psi for more than 12 strands.

ALLOWABLE SUPERIMPOSED LIVE LOADS (KLF)			IBC 2012 & ACI 318-11 (1.2 D + 1.6 L)													
Strand Pattern	Top Bars	Moment Capacity	SPAN													
			16'	18'	20'	22'	24'	26'	28'	30'	32'	34'	36'	38'	40'	42'
8 - 0 - 0	4 - #7	11,319 "k	14.8	12.0	10.1	8.9	7.5	6.4	5.5	4.7	4.1	3.6	3.1	2.8	2.4	2.2
8 - 4 - 0	4 - #8	15,495 "k	20.7	16.8	14.2	12.5	10.6	9.1	7.7	6.7	5.8	5.1	4.5	4.0	3.5	3.2
8 - 6 - 0	6 - #9	17,761 "k	23.8	19.3	16.3	14.4	12.2	10.5	9.0	7.7	6.7	5.9	5.2	4.6	4.1	3.7



2655 Molly Pitcher Hwy. South, Box N
Chambersburg, PA 17201-0813
717-267-4505 Fax 717-267-4518

This table is for simple spans and uniform loads. Design data for any of these span-load conditions is available on request. Individual designs may be furnished to satisfy unusual conditions of heavy loads, concentrated loads, cantilevers, etc...